



Panic Hardware

**DORMA**

**PHA 2000**  
**PHB 3000**



## The modular DORMA Panic Hardware System

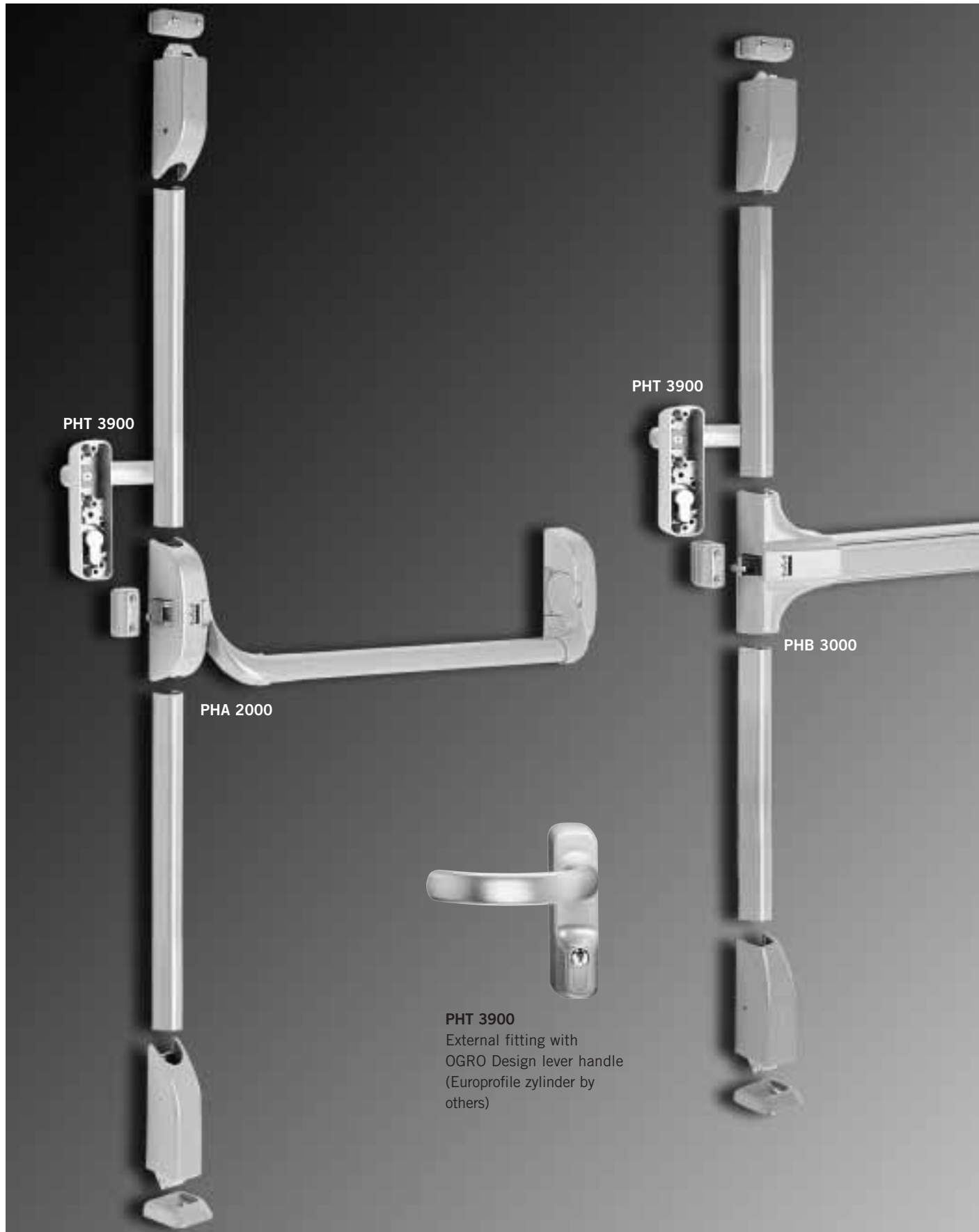

## Forward-looking and innovative hardware for emergency exit doors

The DORMA Panic Hardware System offers an extensive range of high-quality panic hardware fittings with horizontal and vertical locking for use on emergency exit doors where security, reliability and aesthetic elegance are crucial requirements. DORMA PHA, PHB and PHT products fully

meet the demands that are made on fittings used in public buildings, for example, in hospitals, universities and schools, concert halls, shopping centres, hotels and offices. The same DORMA PHT external fittings can be used in conjunction with both series.

### Approval certification

The Panic Hardware products in the DORMA PHA 2000 and PHB 3000 series have been tested and approved to EN 1125 and carry the **CE**-conformity mark in accordance with supplement ZA to that standard.



Additional information on many products can be found at [www.dorma.com](http://www.dorma.com). The abbreviated codes next to the computer symbol  indicate the search terms.

### Contents

	Page
<b>DORMA PH Series 2000/3000</b>	
Features and functions	4
<b>DORMA PHA Series 2000</b>	
Applications and fixing details	6
<b>DORMA PHA Series 2000</b>	
Components	8
<b>DORMA PHB Series 3000</b>	
Applications and fixing details	12
<b>DORMA PHB Series 3000</b>	
Components	14
<b>DORMA PHT 3900</b>	
External fittings	18

## Practical panic hardware for diverse door applications

The DORMA PHA Series 2000 Crossbar, the PHB Series 3000 Pushbar and the universally applicable Series 3900 external fittings, offer a range of products that can be used on both narrow-stile doors as well as on timber doors.

The wide security latchbolt engages in a keep that is normally mounted on the frame. This ensures that the latch is extremely easy to mount and that the door is also securely locked.

### Benefits

#### For the trade

- Modular system for reduced storage costs
- Non-handed
- Universal use of PHT 3900 external fittings

#### For the installer

- Straightforward fixing
- Easy adjustment to different door widths and heights

#### For the architect/specifier

- For horizontal and vertical panic lock mechanisms
- External fitting with OGRO Design lever handle or knob
- Electrical functions for special applications

#### For the user

- Simple operation
- Excellent quality ensures a long lifespan

Data and features	PHA Series 2000			PHB Series 3000		
	1 point	2 point	3 point	1 point	2 point	3 point
Modular System	●	●	●	●	●	●
Standard (not expandable)	–	●	–	●	–	–
Standard doors (single-leaf)	●	●	●	●	●	●
Standard doors (double-leaf)	●	●	–	●	●	–
Fire and smoke check doors (single-leaf) <b>F</b>	●	●	●	●	●	●
Fire and smoke check doors (double-leaf) <b>F</b>	●	●	–	●	●	–
Door width	≤ 1000 mm	●	●	●	●	●
	≤ 1300 mm	●	●	●	●	●
Door height	≤ 2270 mm		●			
	≤ 3400 mm <sup>1)</sup>		●			
	≤ 2265 mm ≤ 3200 mm <sup>1)</sup>				●	●
Max. Door weight (in kg)	200	200	200	200	200	200
Non-handed design	●	●	●	●	●	●
Dogging device <sup>2)</sup>	●	●	●	●	●	●
Security Anti-thrust latch	for Standard doors			●	●	●
	for Fire and smoke check doors	●	●	●	●	●
Electrical unlocking via electric strike	○	○	○	○	○	○
Monitoring switch on pushbar	○	○	○	○	○	○
External fittings PHT 3900						
For Standard doors and Fire and smoke check doors For door leaf thickness up to 60 mm	●	●	●	●	●	●
Extended handle spindle and bolts for door leaf thickness 60 – 105 mm	○	○	○	○	○	○
Approved to EN 1125	●	●	●	●	●	●
<b>CE</b> mark for building products	●	●	●	●	●	●

● = yes    – = no    ○ = option

<sup>1)</sup> Doors higher than 2500 mm lie outside the scope of EN 1125.

<sup>2)</sup> Not for Fire and smoke check doors.

### **F** Approval certification

The DORMA Panic Hardware Series PHA 2000 products marked with the **F** symbol have been tested for use on fire and smoke check doors.

Test reports and/or certificates are available on request.

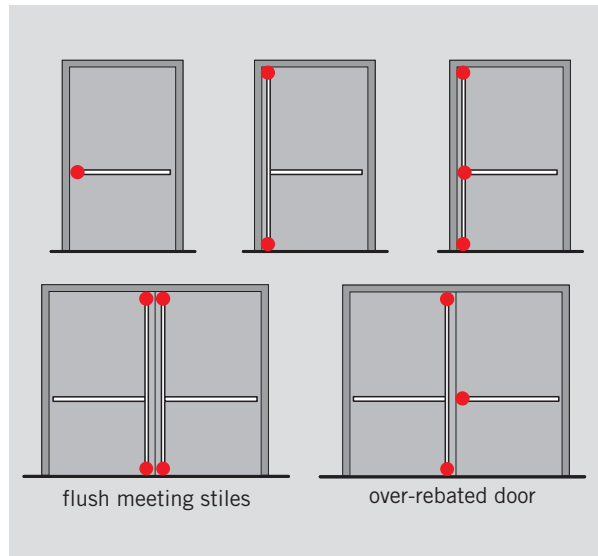
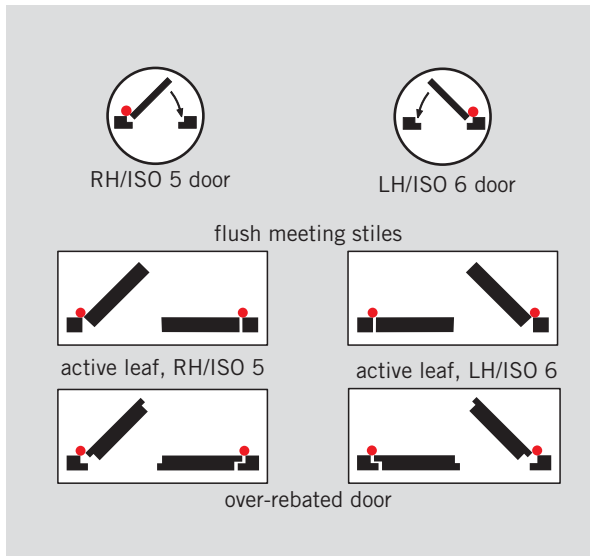

### The modular Panic Hardware System

	PHA	PHB	PHT
Single-point locking •			
Two-point locking • •			
Three-point locking • • •			

### Security anti-thrust latch

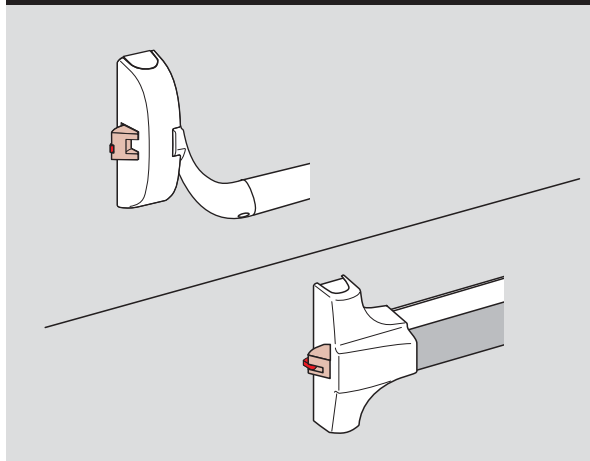

The security anti-thrust latch prevents the latch from being pushed back by unauthorised means when it is in the closed position.

### Dogging device

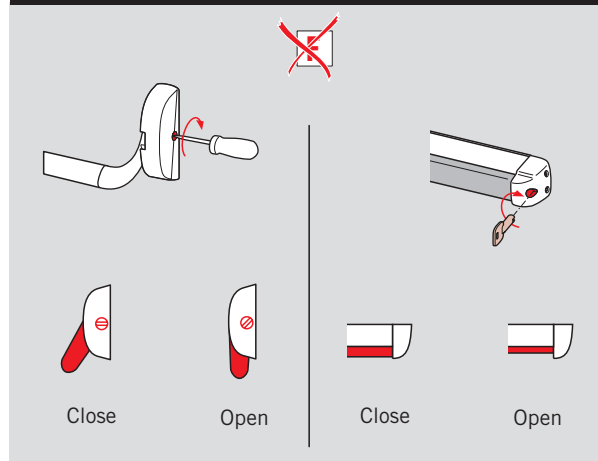

The dogging device serves to hold the latch in its retracted position, so the door is freely accessible.

Single-point locking

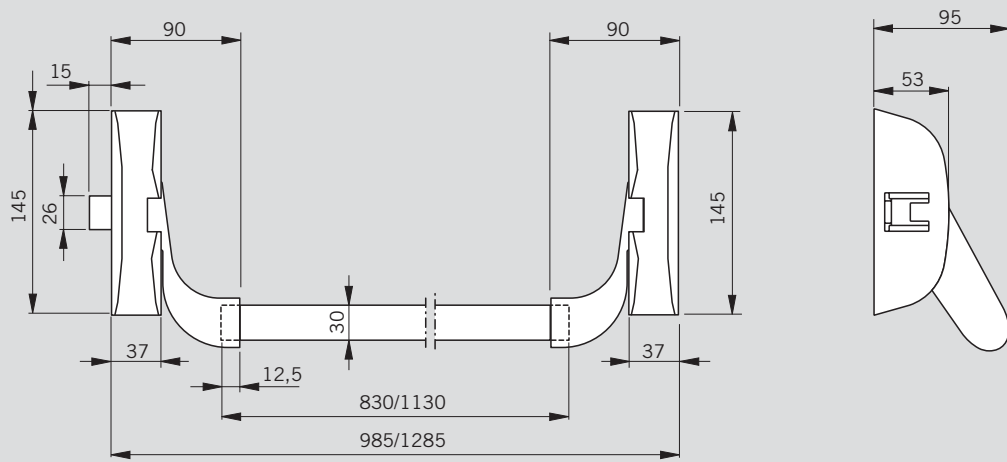

Two/three-point locking

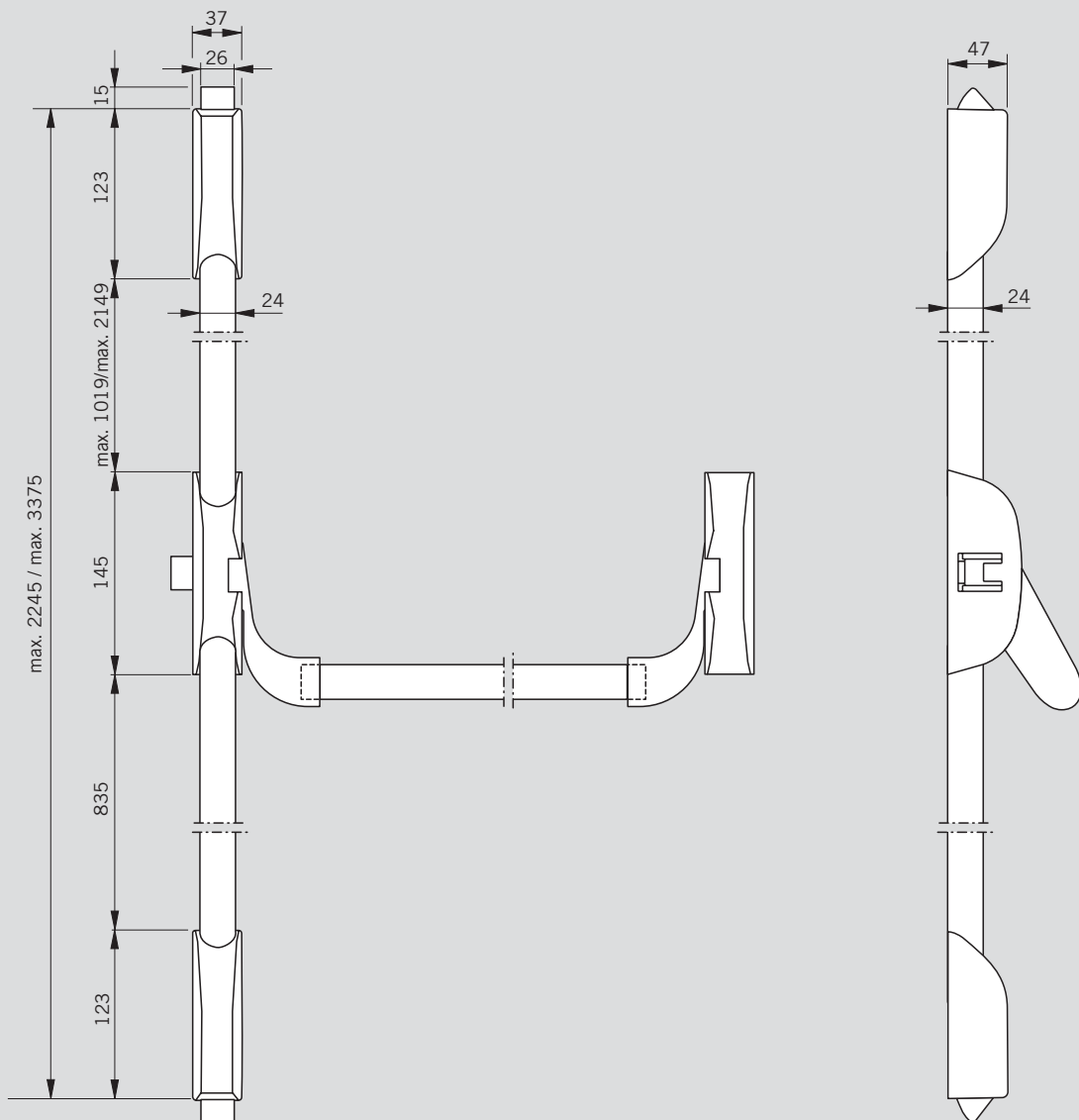

Applications and fixing details

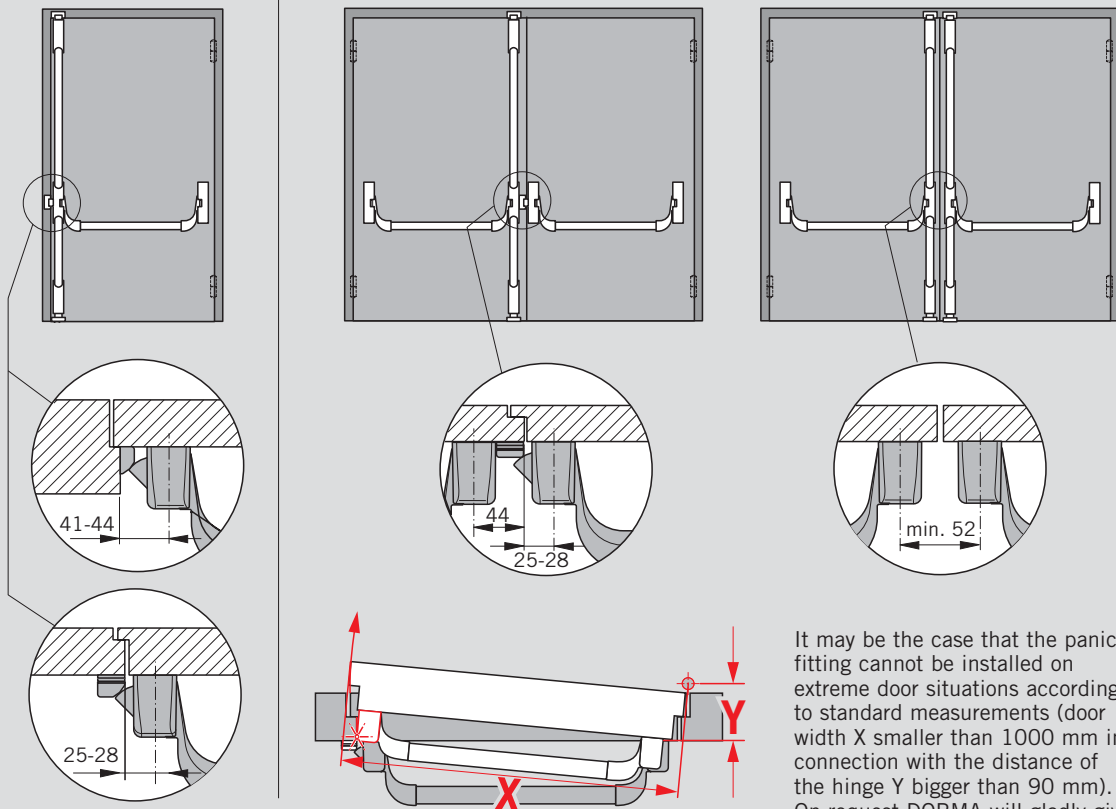
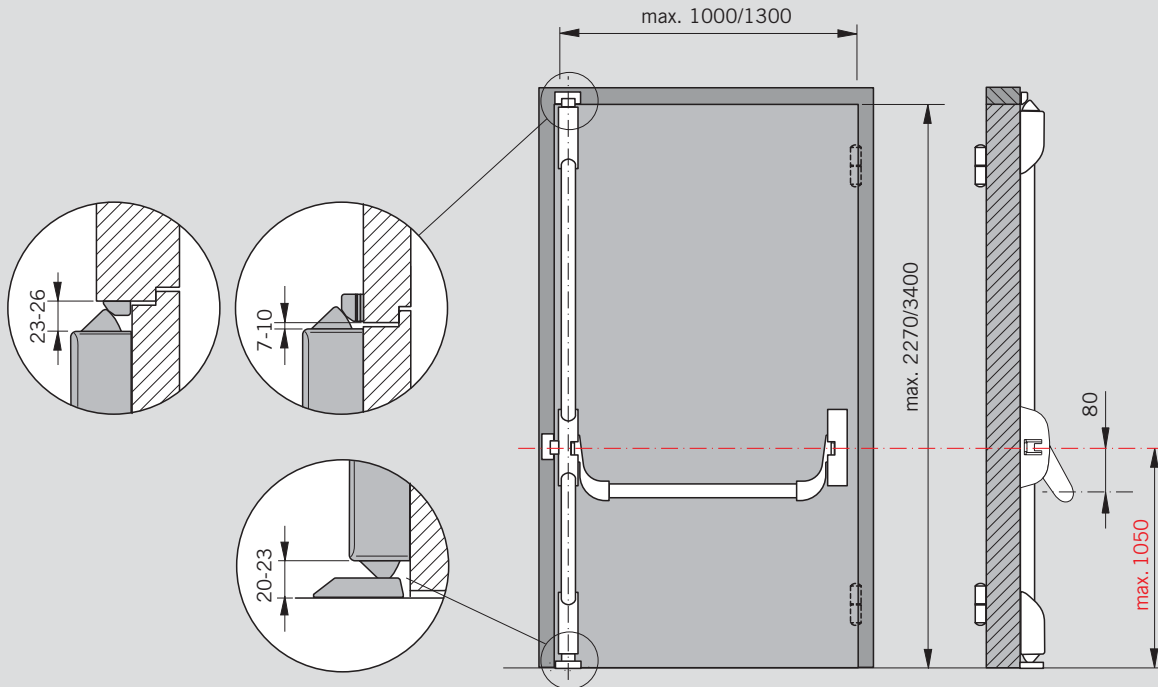

It may be the case that the panic fitting cannot be installed on extreme door situations according to standard measurements (door width X smaller than 1000 mm in connection with the distance of the hinge Y bigger than 90 mm). On request DORMA will gladly give you installation suggestions.

Components on single-leaf doors

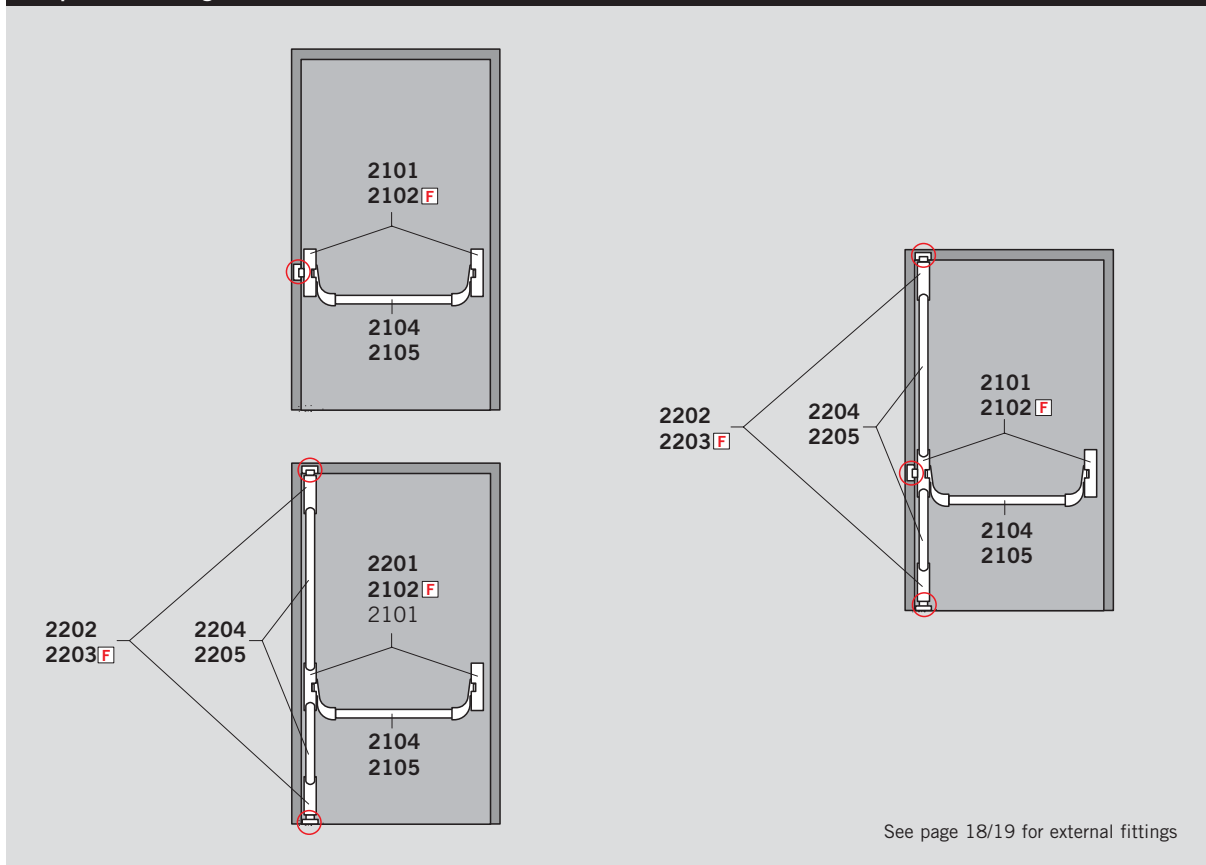

Single-leaf doors

	Single-point modular	Two-point modular	Two-point standard	Three-point modular	
<b>Standard doors</b>	2101 2104 / 2105 <sup>1)</sup>	2101 2104 / 2105 <sup>1)</sup> 2204 / 2205 <sup>2)</sup> 2202	2201 2104 / 2105 <sup>1)</sup> 2204 / 2205 <sup>2)</sup> 2202	2101 2104 / 2105 <sup>1)</sup> 2204 / 2205 <sup>2)</sup> 2202	
<b>Fire and smoke check doors</b> <b>F</b>	2102 2104 / 2105 <sup>1)</sup>	2102 2104 / 2105 <sup>1)</sup> 2204 2203		2101 2104 / 2105 <sup>1)</sup> 2204 2203	

**F** Approval certification

The DORMA Panic Hardware Series PHA 2000 products marked with the **F** symbol have been tested for use on fire and smoke check doors. Test reports and/or certificates are available on request.

**CE**

The DORMA Panic Hardware Series PHA 2000 carry the **CE**-conformity mark.

<sup>1)</sup> 2104 for door widths up to 1000 mm  
2105 for door widths up to 1300 mm

Note:  
According to EN 1125 the effective length of the operating bar has to be at least 60 % of the door width.

<sup>2)</sup> 2204 for door heights up to 2270 mm  
2205 for door heights up to 3400 mm

Note:  
Doors higher than 2500 mm lie outside the scope of EN 1125.



### Components on double doors

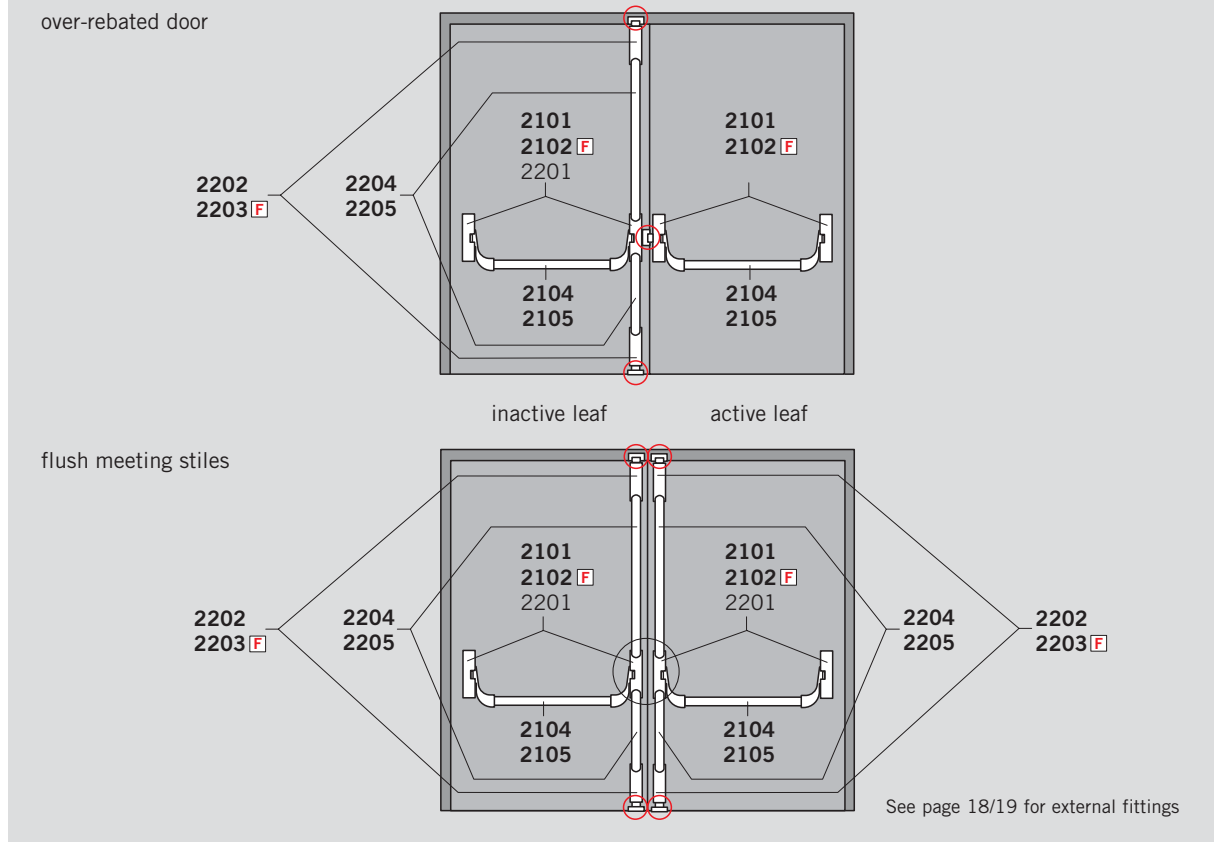

Double doors	Active leaf			Inactive leaf	
	Single-point modular	Two-point modular	Two-point standard	Two-point modular	Two-point standard
<b>Standard doors over-rebated</b>	2101 2104 / 2105 <sup>1)</sup>			2101 2104 / 2105 <sup>1)</sup> 2204 / 2205 <sup>2)</sup> 2202	2201 2104 / 2105 <sup>1)</sup> 2204 / 2205 <sup>2)</sup> 2202
<b>Standard doors flush meeting stiles</b>		2101 2104 / 2105 <sup>1)</sup> 2204 / 2205 <sup>2)</sup> 2202	2201 2104 / 2105 <sup>1)</sup> 2204 / 2205 <sup>2)</sup> 2202	2101 2104 / 2105 <sup>1)</sup> 2204 / 2205 <sup>2)</sup> 2202	2201 2104 / 2105 <sup>1)</sup> 2204 / 2205 <sup>2)</sup> 2202
<b>Fire and smoke check doors over-rebated</b> F	2102 2104 / 2105 <sup>1)</sup>			2102 2104 / 2105 <sup>1)</sup> 2204 2203	
<b>Fire and smoke check doors flush meeting stiles</b> F		2102 2104 / 2105 <sup>1)</sup> 2204 2203		2102 2104 / 2105 <sup>1)</sup> 2204 2203	

## Specification text

**PHA Series 2000**

Panic door bolt tested in accordance with EN 1125, for door widths up to 1300 mm, door heights up to 2270 (in accordance with EN 1125) or 3400 mm; reversible for use on LH/ISO 6 and RH/ISO 5 doors.  
Can be unlocked electrically via electric strike. All products of the Panic Hardware series PHA 2000 carry the **CE** mark.

**PHA 2101**

Single-point locking, modular, for standard doors, without security anti-thrust latch, with dogging device.  
Die-cast zinc latch, zinc latch keep with spacer plates, plastic mounting backplate.

- silver colour
- black

Order No. 35014 .. 

..21010001  
..21010002  PHA 2101

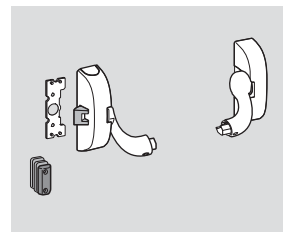
**PHA 2102 F**

Single-point locking, modular, for fire and smoke check doors, with security anti-thrust latch and dogging device.  
Steel latch, steel latch keep with spacer plates, plastic mounting backplate.

- silver colour
- black

..21020001  
..21020002  PHA 2102

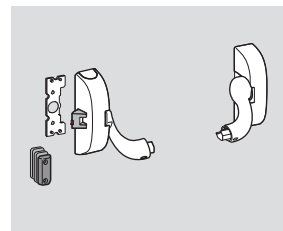
**PHA 2201**

Two-point locking only, with dogging device.  
Plastic mounting backplate.

- silver colour
- black

..22010001  
..22010002  PHA 2201

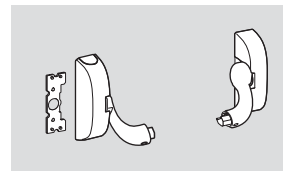
**PHA 2104**

Connecting rod 830 mm (for door widths up to 1000 mm)

- silver colour
- red

..21040001  
..21040002  PHA 2104

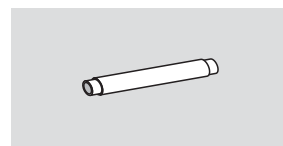







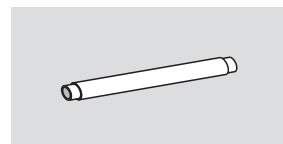



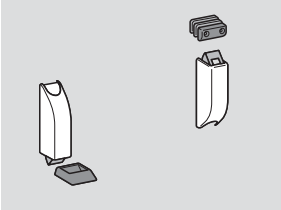

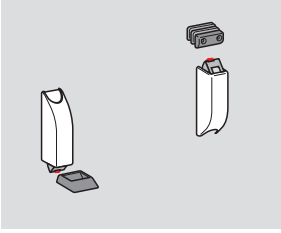
**PHA 2105**

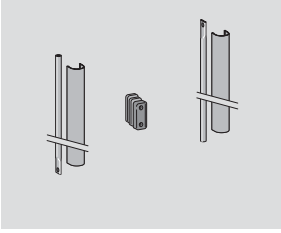
Connecting rod 1130 mm (for door widths up to 1300 mm)

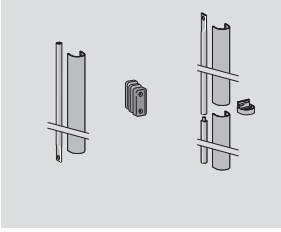
- silver colour
- red

..21050001  
..21050002  PHA 2105

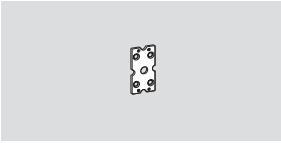

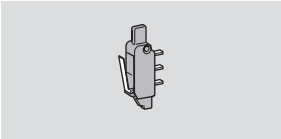
Specification text	Order No. 35014 .. 	
<p><b>PHA 2202</b> Top and bottom lock combination, without security anti-thrust latch. Die-cast zinc latch, zinc top latch keep with spacer plates, steel bottom latch keep.</p> <p><input type="checkbox"/> silver colour <input type="checkbox"/> black</p>	<p>..22020001 ..22020002  PHA 2202</p>	
<p><b>PHA 2203 <span style="border: 1px solid black; padding: 0 2px;">F</span></b> Top and bottom lock combination, for fire and smoke check doors, with security anti-thrust latch. Steel latch, steel top latch keep with spacer plates, steel bottom latch keep.</p> <p><input type="checkbox"/> silver colour <input type="checkbox"/> black</p>	<p>..22030001 ..22030002  PHA 2203</p>	
<p><b>PHA 2204</b> Connecting rod set with cover for door heights up to 2270 mm. Steel latch keep with spacer plates for double doors.</p> <p><input type="checkbox"/> silver colour <input type="checkbox"/> black</p>	<p>..22040001 ..22040002  PHA 2204</p>	
<p><b>PHA 2205</b> Connecting rod set with cover for door heights up to 3400 mm. Steel latch keep with spacer plates for double doors.</p> <p><input type="checkbox"/> silver colour <input type="checkbox"/> black</p>	<p>..22050001 ..22050002  PHA 2205</p>	
<p><b>Mounting backplate</b> Steel, galvanised (in packs of 10) for PHA 2101, 2102, 2201 for factory pre-installation to simplify field installation</p>	<p>..25200050  PHA Accessories</p>	
<p><b>Mounting backplate</b> Steel, galvanised (in packs of 10) for PHA 2202, 2203 for factory pre-installation to simplify field installation</p>	<p>..25200051  PHA Accessories</p>	
<p><b>Micro-switch</b> For actuation of visual or audible signals. Contact rating: max. 48 V DC, max. 3 A For PHA 2101, 2102, 2201</p>	<p>..25200060  PHA Accessories</p>	

Single-point locking

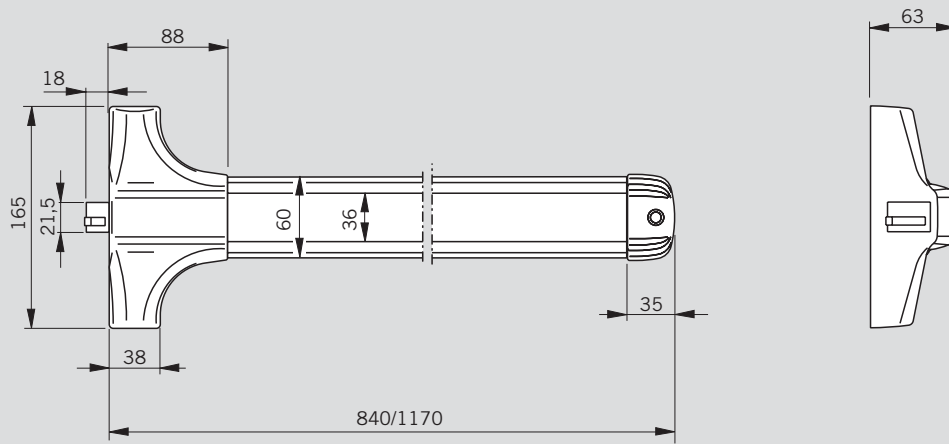

Two/three-point locking

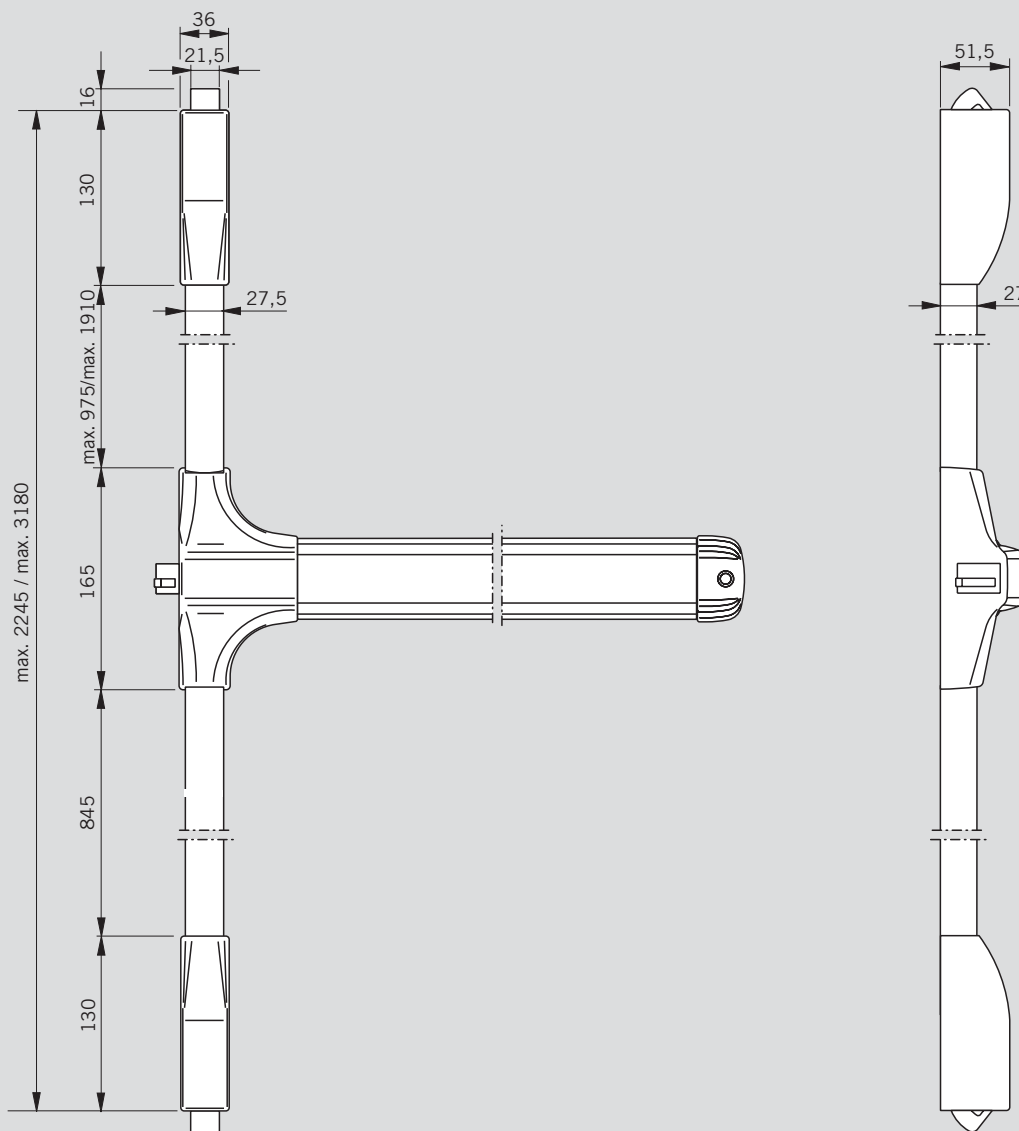

Applications and fixing details

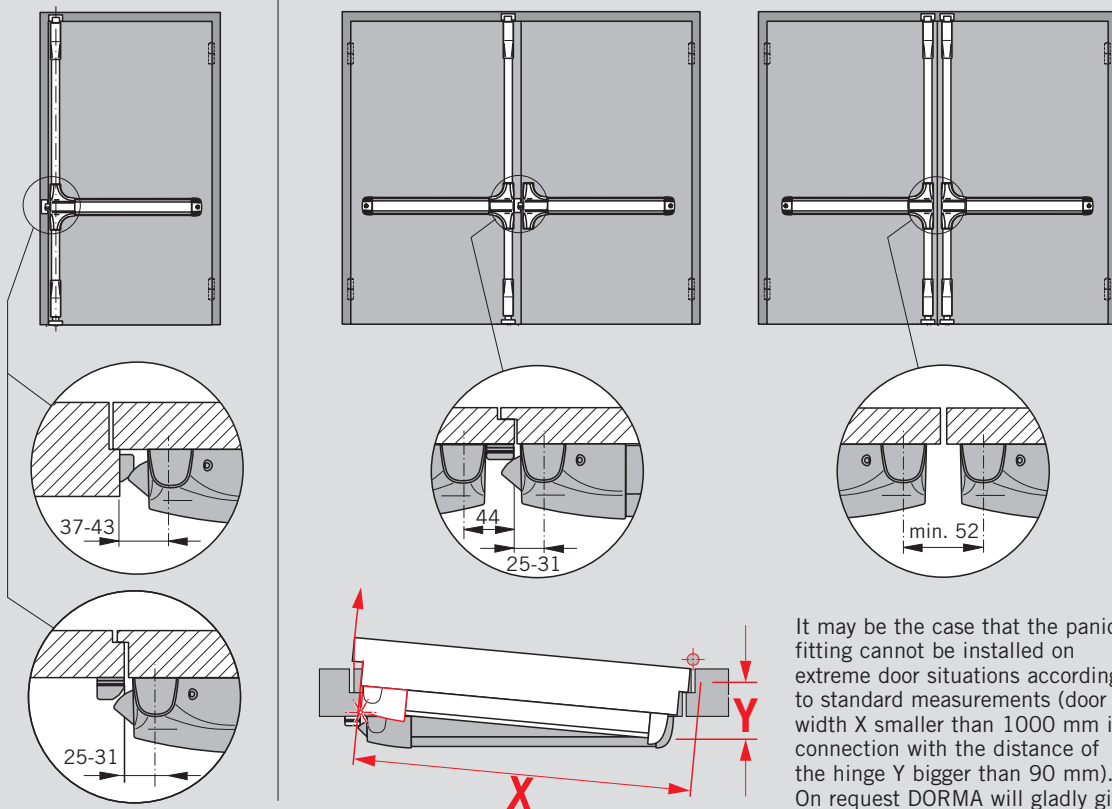
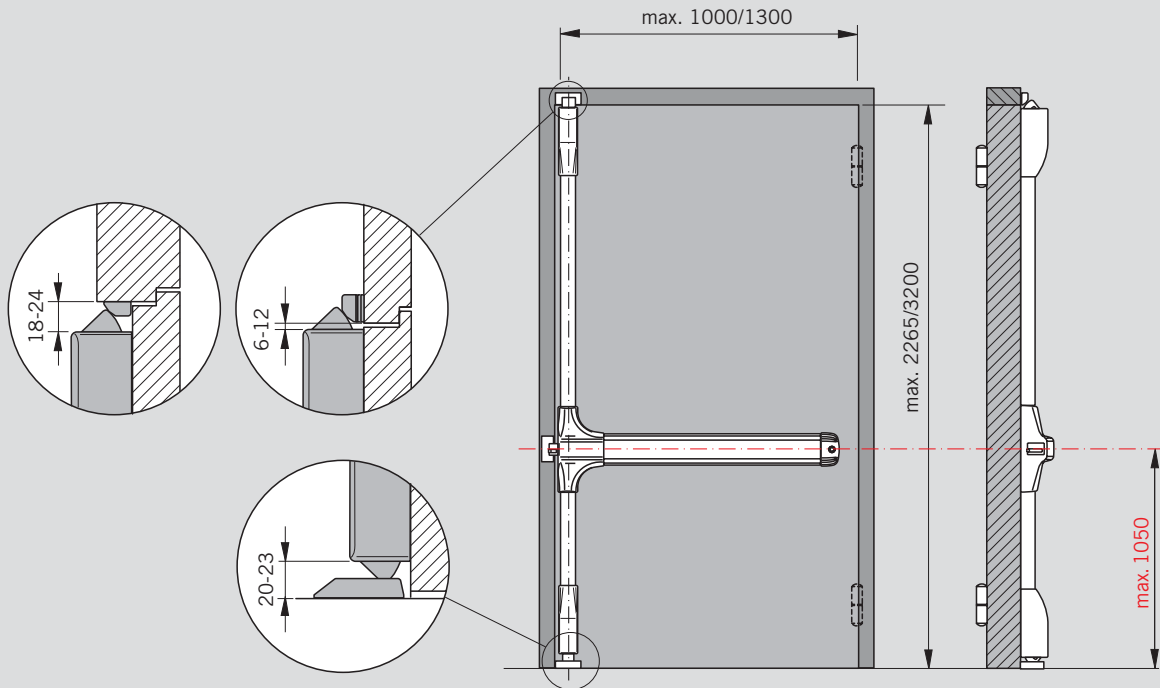

It may be the case that the panic fitting cannot be installed on extreme door situations according to standard measurements (door width X smaller than 1000 mm in connection with the distance of the hinge Y bigger than 90 mm). On request DORMA will gladly give you installation suggestions.

Components on single-leaf doors

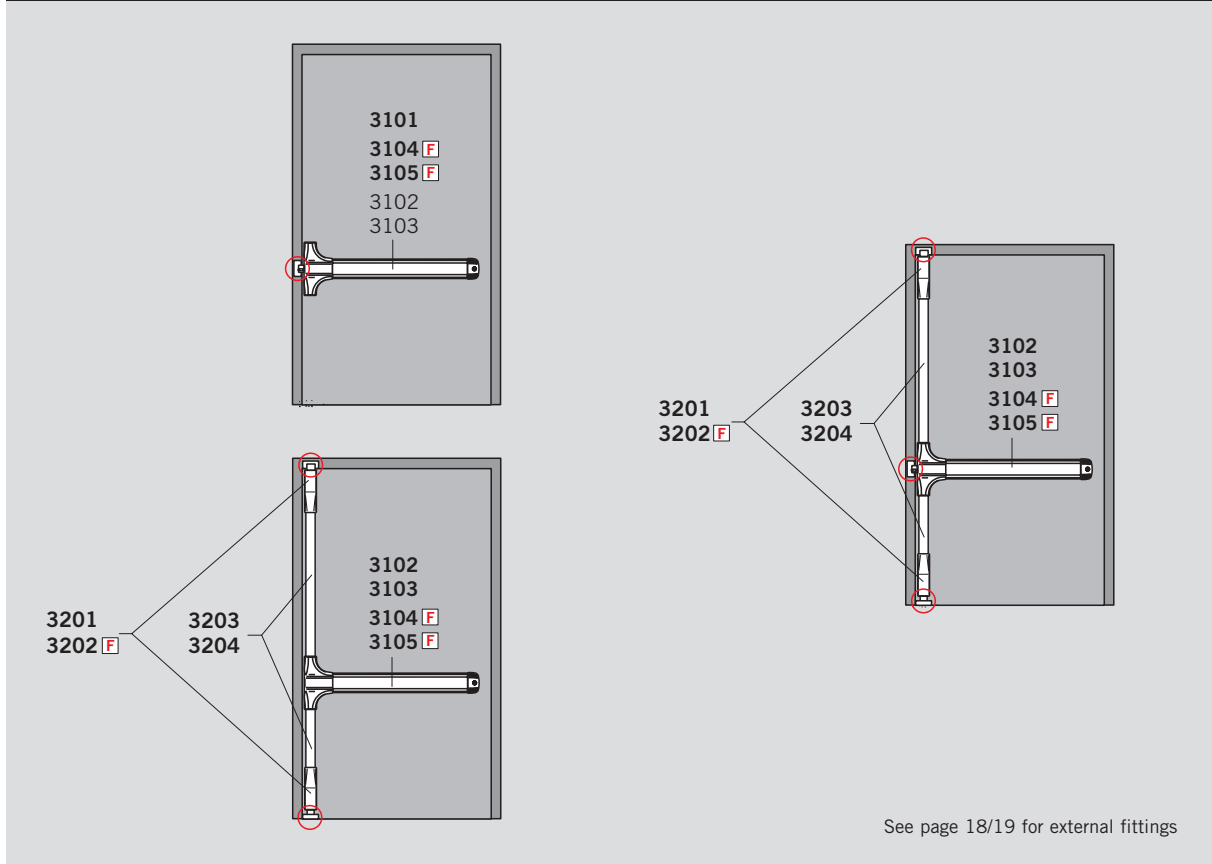

Single-leaf doors

	Single-point modular	Single-point standard	Two-point modular	Three-point modular	
<b>Standard doors</b>	3102 / 3103 <sup>1)</sup>	3101	3102 / 3103 <sup>1)</sup> 3203 / 3204 <sup>2)</sup> 3201	3102 / 3103 <sup>1)</sup> 3203 / 3204 <sup>2)</sup> 3201	
<b>Fire and smoke check doors</b> <b>F</b>	3104 / 3105 <sup>1)</sup>		3104 / 3105 <sup>1)</sup> 3203 3202	3104 / 3105 <sup>1)</sup> 3203 3202	

**F** Approval certification

The DORMA Panic Hardware Series PHB 3000 products marked with the **F** symbol have been tested for use on fire and smoke check doors. Test reports and/or certificates are available on request.

**CE**

The DORMA Panic Hardware Series PHB 3000 carry the **CE**-conformity mark.

<sup>1)</sup> 3102, 3104 for door widths up to 1000 mm  
3103, 3105 for door widths up to 1300 mm

Note:  
According to EN 1125 the effective length of the operating bar has to be at least 60 % of the door width.

<sup>2)</sup> 3203 for door heights up to 2265 mm  
3204 for door heights up to 3200 mm

Note:  
Doors higher than 2500 mm lie outside the scope of EN 1125.

### Components on double doors

over-rebated door

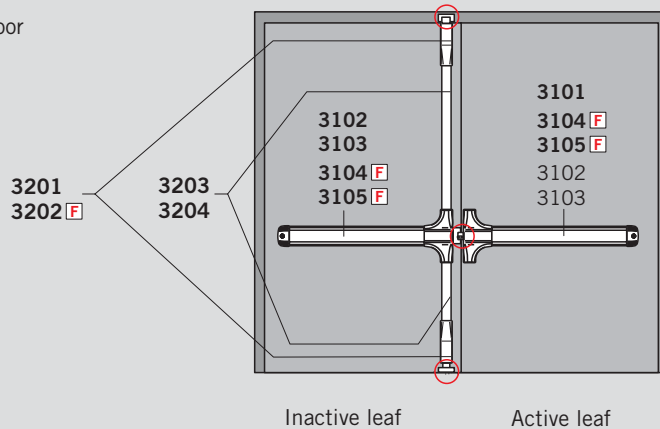

flush meeting stiles

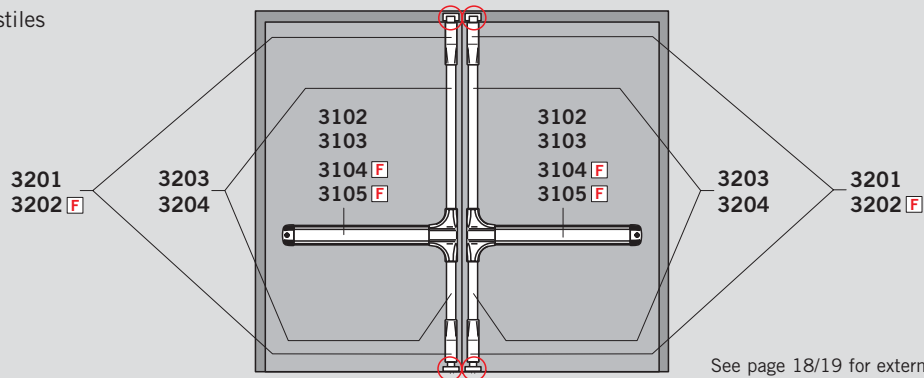

See page 18/19 for external fittings

Double doors	Active leaf			Inactive leaf	
	Single-point modular	Single-point standard	Two-point modular	Three-point modular	
Standard doors over-rebated	3102 / 3103 <sup>1)</sup>	3101		3102 / 3103 <sup>1)</sup> 3203 / 3204 <sup>2)</sup> 3201	
Standard doors flush meeting stiles			3102 / 3103 <sup>1)</sup> 3203 / 3204 <sup>2)</sup> 3201	3102 / 3103 <sup>1)</sup> 3203 / 3204 <sup>2)</sup> 3201	
Fire and smoke check doors over-rebated <b>F</b>	3104 / 3105 <sup>1)</sup>			3104 / 3105 <sup>1)</sup> 3203 3202	
Fire and smoke check doors flush meeting stiles <b>F</b>			3104 / 3105 <sup>1)</sup> 3203 3202	3104 / 3105 <sup>1)</sup> 3203 3202	

## Specification text

**PHB Series 3000**

Panic door bolt tested in accordance with EN 1125, for door widths up to 1300 mm, door heights up to 2265 (in accordance with EN 1125) or 3200 mm, non-handed. Can be unlocked electrically via electric strike. All products of the Panic Hardware series PHB 3000 carry the **CE** mark.

**PHB 3101**

Single-point locking, standard, for standard doors with a door width up to 1000 mm, with security anti-thrust latch and dogging device.

Die-cast zinc latch,  
steel latch keep with spacer plates.

- silver colour
- black/red

Order No. 35014 .. 

..31010001  
..31010002  PHB 3101

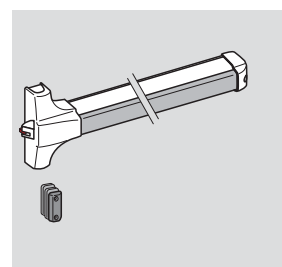
**PHB 3102**

Single-point locking, modular, for standard doors with a door width up to 1000 mm, with security anti-thrust latch and dogging device.

Die-cast zinc latch,  
steel latch keep with spacer plates.

- silver colour
- black/red

..31020001  
..31020002  PHB 3102

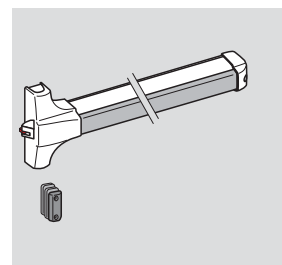
**PHB 3103**

Single-point locking, modular, for standard doors with a door width up to 1300 mm, with security anti-thrust latch and dogging device.

Die-cast zinc latch,  
steel latch keep with spacer plates.

- silver colour
- black/red

..31030001  
..31030002  PHB 3103

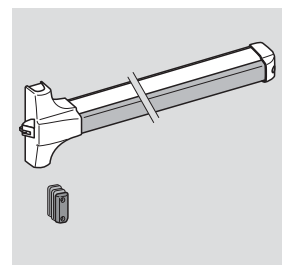
**PHB 3104** 

Single-point locking, modular, for fire and smoke check doors with a door width up to 1000 mm, with security anti-thrust latch and dogging device.

Steel latch, steel latch keep with spacer plates.

- silver colour
- black/red

..31040001  
..31040002  PHB 3104

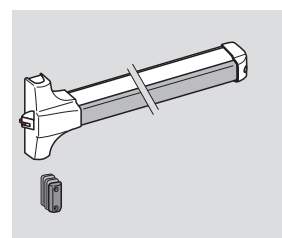
**PHB 3105** 

Single-point locking, modular, for fire and smoke check doors with a door width up to 1300 mm, with security anti-thrust latch and dogging device.







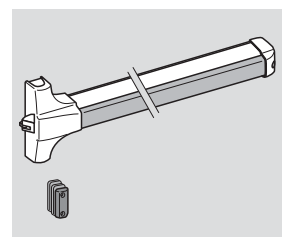

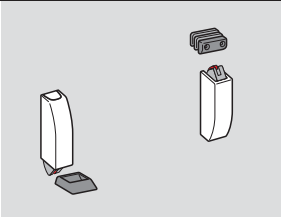

Steel latch, steel latch keep with spacer plates.

- silver colour
- black/red

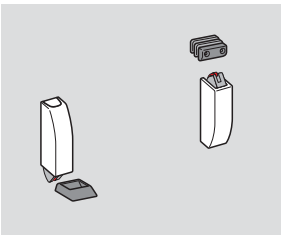
..31050001  
..31050002  PHB 3105

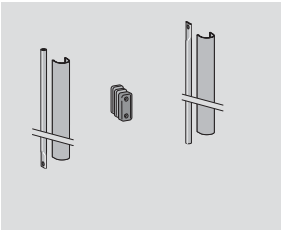

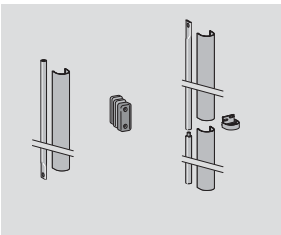

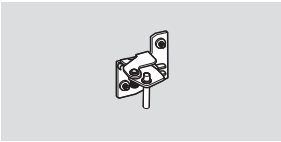
Specification text	Order No. 35014 .. 	
<p><b>PHB 3201</b>            Top and bottom lock combination, with security anti-thrust latch.            Die-cast zinc latch, steel top latch keep with spacer plates,            steel bottom latch keep.</p> <p><input type="checkbox"/> silver colour  <input type="checkbox"/> black</p>	<p>..32010001            ..32010002  PHB 3201</p>	
<p><b>PHB 3202 <span style="border: 1px solid black; padding: 0 2px;">F</span></b>            Top and bottom lock combination, for fire and smoke            check doors, with security anti-thrust latch.            Steel latch, steel top latch keep with spacer plates,            steel bottom latch keep.</p> <p><input type="checkbox"/> silver colour  <input type="checkbox"/> black</p>	<p>..32020001            ..32020002  PHB 3202</p>	
<p><b>PHB 3203</b>            Connecting rod set with cover for door heights            up to 2265 mm            Steel latch keep with spacer plates,            for double doors.</p> <p><input type="checkbox"/> silver colour  <input type="checkbox"/> black</p>	<p>..32030001            ..32030002  PHB 3203</p>	
<p><b>PHB 3204</b>            Connecting rod set with cover for door heights            up to 3200 mm            Steel latch keep with spacer plates,            for double doors.</p> <p><input type="checkbox"/> silver colour  <input type="checkbox"/> black</p>	<p>..32040001            ..32040002  PHB 3204</p>	
<p><b>Micro-switch</b>            For actuating visual or audible signals.            Contact rating: max. 48 V DC, max. 3 A            For PHB 3101, 3102, 3103, 3104, 3105.</p>	<p>..35200061  PHB            Accessories</p>	

3901, 3903, 3905

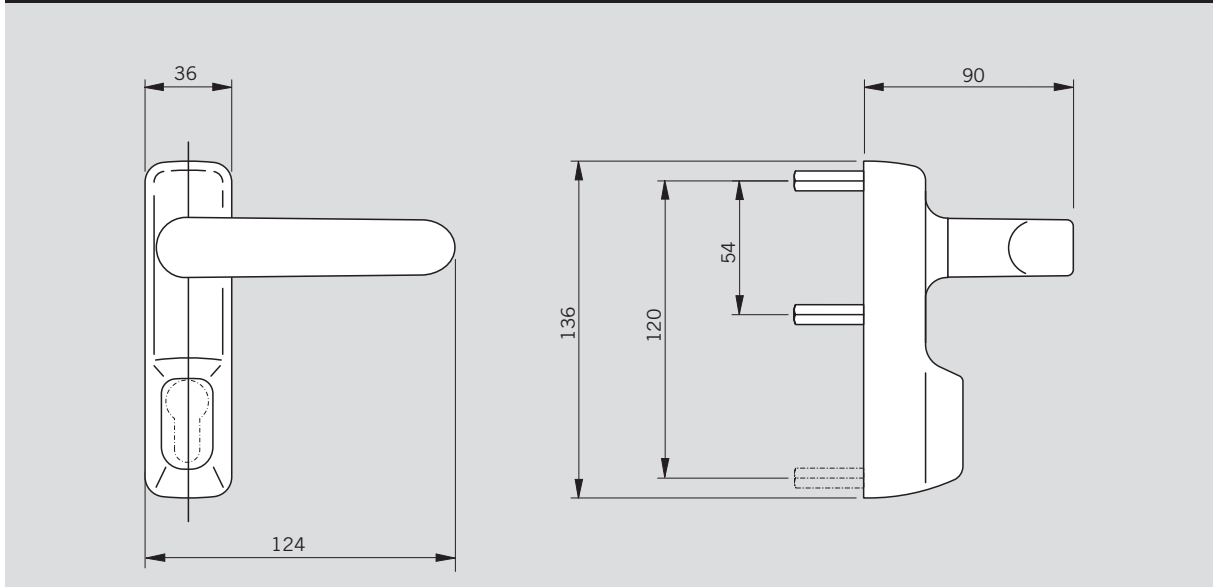

3902, 3904

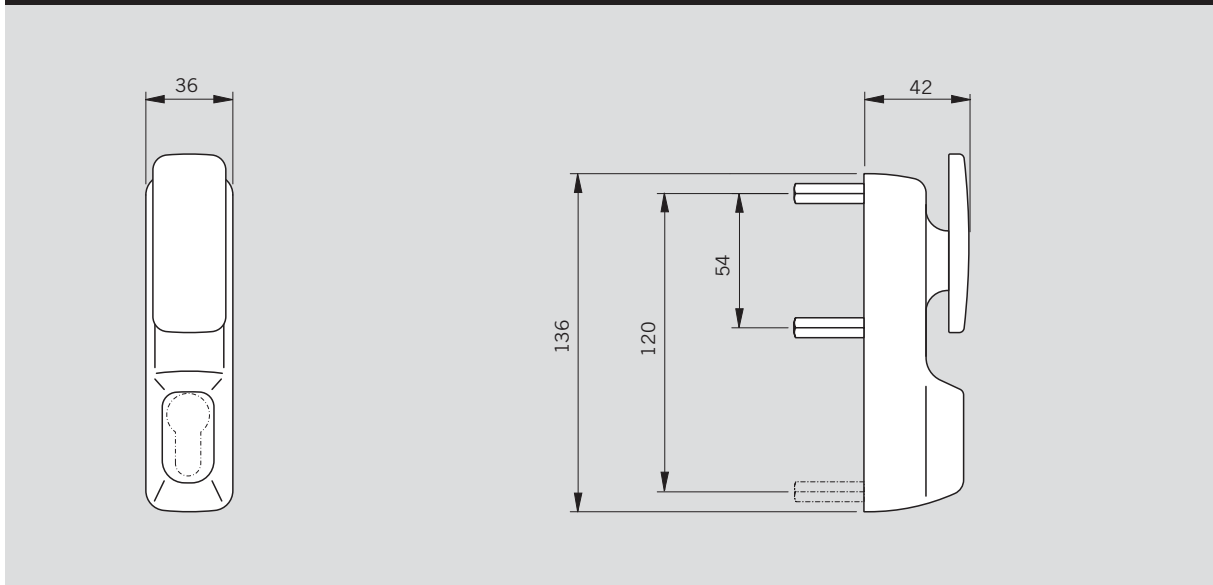









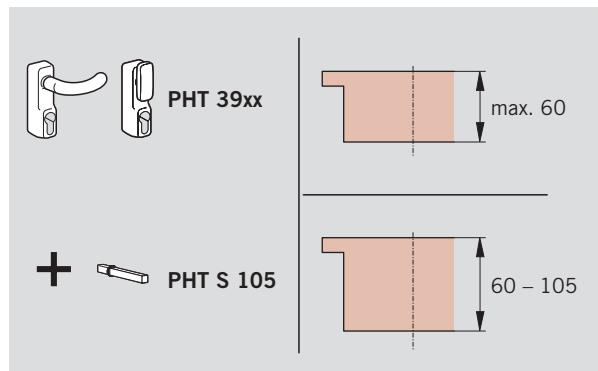



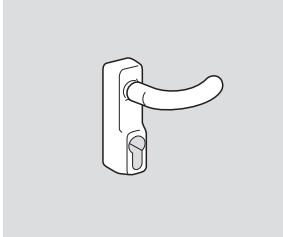

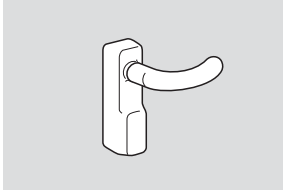

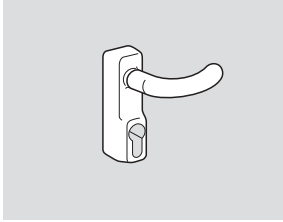

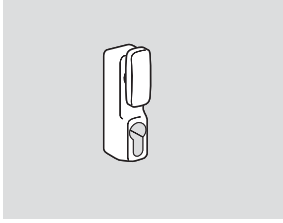
**F**

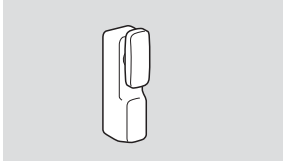
When DORMA PHT 3905 external fittings are used on fire and smoke check doors in conjunction with the PHA or PHB Panic Hardware series, the appropriate seal set must be used.

**CE**

The DORMA Panic Hardware Series PHT 3900 carry the **CE**-conformity mark.

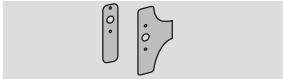

Specification text	Order no. 35014 .. 	
<p><b>PHT 3901</b> External fitting with OGRO Design lever handle, for standard doors with a door leaf thickness up to 60 mm, prepared for Europrofile single cylinder. With handle spindle and 2 cylinder fixing bolts.</p> <p><input type="checkbox"/> silver colour <input type="checkbox"/> black</p>	<p>..39010001 ..39010002  PHT 3901</p>	
<p><b>PHT 3903</b> External fitting with OGRO Design lever handle, for standard doors with a door leaf thickness up to 60 mm, non-lockable. With handle spindle.</p> <p><input type="checkbox"/> silver colour <input type="checkbox"/> black</p>	<p>..39030001 ..39030002  PHT 3903</p>	
<p><b>PHT 3905</b>  External fitting with OGRO Design lever handle, for fire and smoke check doors with a door leaf thickness up to 60 mm. With integrated seal ring. Prepared for Europrofile single cylinder. With handle spindle and 2 cylinder fixing bolts.</p> <p><input type="checkbox"/> silver colour <input type="checkbox"/> black</p>	<p>..39050001 ..39050002  PHT 3905</p>	
<p><b>PHT 3902</b> External fitting with knob, for standard doors with a door leaf thickness up to 60 mm, prepared for Europrofile single cylinder. With handle spindle and 2 cylinder fixing bolts.</p> <p><input type="checkbox"/> silver colour <input type="checkbox"/> black</p>	<p>..39020001 ..39020002  PHT 3902</p>	
<p><b>PHT 3904</b> External fitting with knob, for standard doors with a door leaf thickness up to 60 mm, non-lockable. With handle spindle.</p> <p><input type="checkbox"/> silver colour <input type="checkbox"/> black</p>	<p>..39040001 ..39040002  PHT 3904</p>	
<p><b>PHT S 105</b> <b>Extended handle spindle</b>, 8 mm square, incl. fixings for door leaf thicknesses from 60 to 105 mm.</p>	<p>..39200050  PHT Accessories</p>	
<p> <b>Seal set</b> for external fitting and <b>PHA</b> panic door locks on fire and smoke check doors.</p>	<p>..39200060  PHT Accessories</p>	
<p> <b>Seal set</b> for external fitting and <b>PHB</b> panic door locks on fire and smoke check doors.</p>	<p>..39200061  PHT Accessories</p>	

# Your Partners Worldwide

**DORMA GmbH + Co. KG**  
Division Door Control  
[www.dorma.com](http://www.dorma.com)

#### **Australia**

DORMA Door Controls Pty. Ltd.  
P.O. Box 1092  
Narre Warren Vic 3805  
52 Abbott Road  
Hallam/Victoria 3803  
Australia  
Phone: +61 3/97 96 35 55  
Fax: +61 3/97 96 39 55

#### **Central Europe**

DORMA GmbH + Co. KG  
Postfach 40 09  
D-58247 Ennepetal  
Phone: +49 23 33/793-0  
Fax: +49 23 33/79 34 95

#### **Emerging Markets**

DORMA GmbH + Co. KG  
Postfach 40 09  
D-58247 Ennepetal  
Phone: +49 23 33/7 93-0  
Fax: +49 23 33/79 34 95

#### **Far East**

DORMA Door Controls Pte. Ltd.  
No. 2 Jalan Terusan, Jurong  
Singapore 619285  
Phone: +65 62 68/76 33  
Fax: +65 62 65/79 95

#### **France**

DORMA France S.A.S  
Europarc  
42/44, rue Eugène Dupuis  
F-94046 Creteil Cedex  
Phone: +33 1/41 94 24 00  
Fax: +33 1/41 94 24 01

#### **Gulf**

DORMA Gulf Door Controls FZE  
Jebel Ali Free Zone  
Roundabout 8  
Unit VC 02, P.O. Box 17268  
Jebel Ali  
Dubai, United Arab Emirates  
Phone: +971 48/83 90 14  
Fax: +971 48/83 90 15

#### **DORMA Group North America**

DORMA Door Controls  
DORMA Drive  
Reamstown, Pa. 17567, U.S.A.  
Phone: +1717/3 36 38 81  
Fax: +1717/3 36 21 06

#### **ScanBalt**

DORMA Danmark A/S  
Sindalvej 6 – 8  
DK-2610 Rødovre  
Phone: +45 44/94 30 77  
Fax: +45 44/94 95 04

#### **South Africa**

DORMA Door Controls (Pty.) Ltd.  
Kings Court  
4A Mineral Crescent  
ZA-2000 Crown/Gauteng  
Johannesburg  
Phone: +27 11/8 30 02 80  
Fax: +27 11/8 30 02 91

#### **South America**

DORMA Sistemas de Controles  
para Portas Ltda.  
Av. Piracema, 1400  
Centro Empresarial Tambore  
CEP 06400 Barueri/  
São Paulo, Brasil  
Phone: +55 11/41 91 22 38  
Fax: +55 11/41 91 22 83

#### **South-East Europe**

DORMA AUSTRIA GmbH  
Pebering Strass 22  
A-5301 Eugendorf  
Phone: +43 62 25/2 84 88  
Fax: +43 62 25/2 84 91

#### **South Europe**

DORMA Italiana S.r.l.  
Via. A. Canova 44/46  
I-20035 Lissone (MI)  
Phone: +39 039/24 40 31  
Fax: +39 039/24 40 33 10

#### **DORMA Ibérica, S.A.**

Camino San Martín de la Vega, 4  
E-28500 Arganda del Rey  
(Madrid)  
Phone: +34 91/8 75 78 50  
Fax: +34 91/8 75 78 81

#### **UK/Ireland**

DORMA UK Limited  
Door Controls Division  
DORMA Trading Park  
Staffa Road  
London E10 7QX  
Phone: +44 208 558 8411  
Fax: +44 208 558 6122

